

# TC3.P Control Hub

PUSH BUTTON SWITCH

**FEATURES**

- Complete electrical control hub
- Atmel 8-bit AVR® RISC-based microcontroller
- Trench type MOSFET powered
- Solid State design for water-proof and shock-proof operation
- 4 layer PCB design utilizing SMD components
- PTC smart fuse protection with auto reset
- Optimized for LED lighting
- On board "fly-back" protection circuit
- AC/DC voltage runaway engine shutdown protection
- Enhanced engine power protection with quick blow fuse
- Complete color-coded wiring harness
- No start ignition coil time-out power off
- Starter motor safety lock out with anti-grind
- Starter motor max crank time out
- Brake light flash pre-warning (Selectable)
- Onboard digital flasher (Selectable)
- Intelligent directional switching signal light
- "PARK" position light feature (Brake light)
- Master light control (Headlight only)
- Sensor inputs
- Dash gauge outputs (Standard)
- Soft start headlight ON
- Engine run monitoring
- Multi-use internally protected power output
- Handlebar switch size (7/8", 22mm)
- 1 year replacement warranty & tech service

**INCLUDES**

- TC3.P Control Hub
- Plug in wiring harness (Power, Output, Input, Dash)
- Plug&Go handlebar switch set (Push button type)
- GND harness

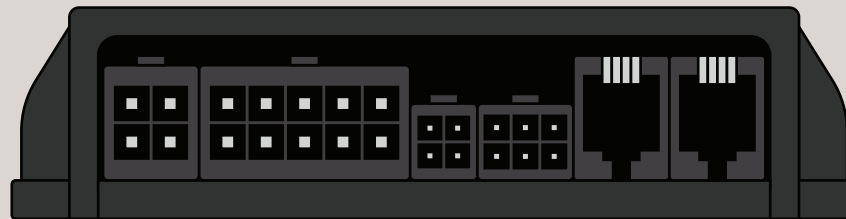
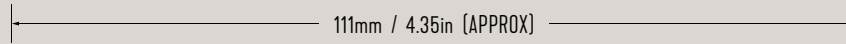
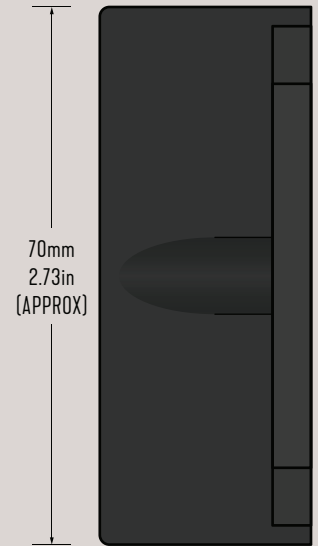
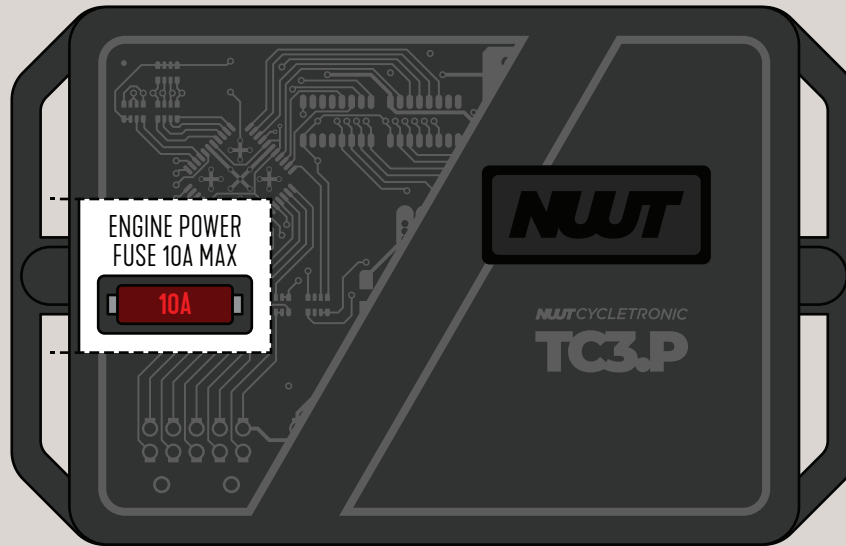

**HARNESSES:**

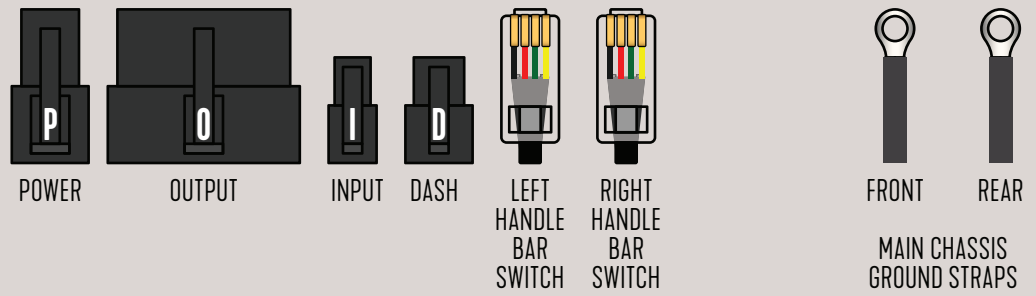

# TC3.P

## Pinouts

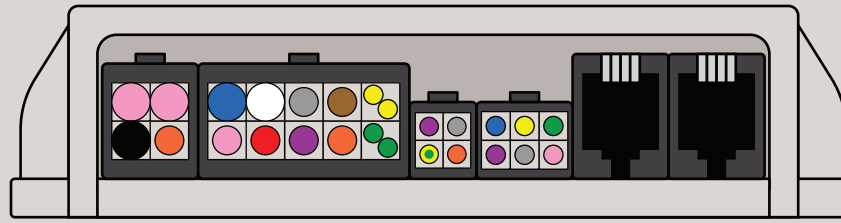

POWER      OUTPUT      INPUT      DASH      LEFT      RIGHT

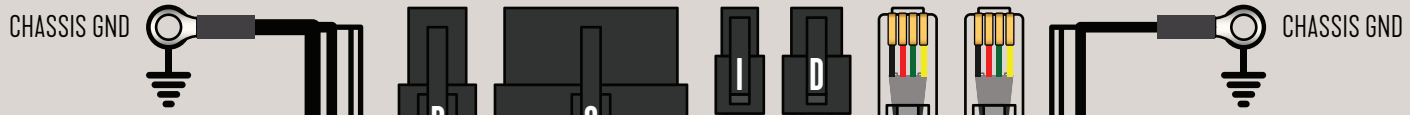

### FRONT GND

GND	16AWG, 0.5m	(-)	DASH/DRL/HEADLIGHT
GND	18AWG, 0.5m	(-)	HORN
GND	22AWG, 0.5m	(-)	LEFT TURN SIGNAL
GND	22AWG, 0.5m	(-)	RIGHT TURN SIGNAL

### POWER

K+	16AWG, 1.25m	(+)	KEY SWITCH POWER IN (LONG)
GND	16AWG, 0.25m	(-)	CHASSIS GROUND IN
S+	16AWG, 0.25m	(+)	SPARE SWITCH POWER OUT (SHORT)
P+	18AWG, 1.25m	(+)	PARK LIGHT SWITCH IN

### OUTPUT

HI	16AWG, 1.25m	(+)	HEADLIGHT HIGH BEAM
F+	18AWG, 0.25m	(+)	PROTECTED POWER
LO	16AWG, 1.25m	(+)	HEADLIGHT LOW BEAM
ENGINE	18AWG, 0.75m	(+)	ENGINE IGNITION POWER
HORN	18AWG, 0.75m	(+)	HORN
STARTER	18AWG, 0.5m	(+)	STARTER SOLENOID / RELAY
TAILLIGHT	18AWG, 0.75m	(+)	TAIL LIGHT MARKER
BRAKELIGHT	18AWG, 0.75m	(+)	BRAKE LIGHT
LEFT TURN	(2) 22AWG, 1.25m, 0.75m	(+)	LEFT TURN SIGNAL LIGHTS (FRONT & REAR)
RIGHT TURN	(2) 22AWG, 1.25m, 0.75m	(+)	RIGHT TURN SIGNAL LIGHTS (FRONT & REAR)

### INPUT

OIL	22AWG, 0.75m	(-)	OIL SWITCH
RUN SENSE	22AWG, 0.75m	(~)	IGNITION COIL TRIGGER
NEUTRAL	22AWG, 0.75m	(-)	NEUTRAL SWITCH
REAR BRAKE	22AWG, 0.75m	(-)	REAR BRAKE SWITCH

### REAR GND

GND	18AWG, 0.5m	(-)	BRAKE/TAIL LIGHT
GND	22AWG, 0.5m	(-)	RIGHT TURN SIGNAL LIGHT
GND	22AWG, 0.5m	(-)	LEFT TURN SIGNAL LIGHT

**RIGHT HANDLEBAR SWITCH**

**LEFT HANDLEBAR SWITCH**

### DASH

D+	22AWG, 1.25m	(+)	GAUGE POWER
RIGHT TURN	22AWG, 1.25m	(+)	RIGHT TURN INDICATOR
NEUTRAL	22AWG, 1.25m	(-)	NEUTRAL INDICATOR
LEFT TURN	22AWG, 1.25m	(+)	LEFT TURN INDICATOR
OIL	22AWG, 1.25m	(-)	OIL INDICATOR
HI	22AWG, 1.25m	(+)	HIGH BEAM INDICATOR

# TC3.P Switch Set

ALL MOMENTARY (SELF-RETURN)  
PUSH BUTTON TYPE (2 LEFT, 2 RIGHT)

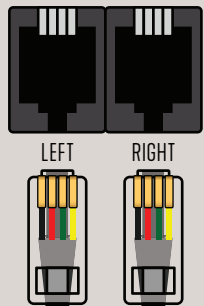
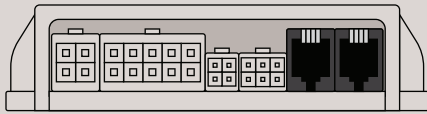

LEFT

RIGHT

TURN HANDLEBAR LEFT AND RIGHT, LOCK TO LOCK, WHEN ROUTING SWITCH SET CABLES TO ENSURE YOU HAVE PROPER CABLE SLACK.

## UPPER LEFT BUTTON

SINGLE (1) TAP  
TOGGLE LEFT TURN SIGNAL ON/OFF  
HAZARD LIGHTS OFF

HOLD LEFT + RIGHT BUTTONS  
HAZARD LIGHTS ON



## LOWER LEFT BUTTON

SINGLE (1) TAP  
TOGGLE HEADLIGHT HI/LO

TRIPLE (3) TAPS  
HEADLIGHT ON/OFF

HOLD BUTTON  
HORN



CLUTCH SWITCH WIRES  
(NO SWITCH = CONNECT TOGETHER)

## UPPER RIGHT BUTTON

SINGLE (1) TAP  
TOGGLE RIGHT TURN SIGNAL ON/OFF  
HAZARD LIGHTS OFF

HOLD LEFT + RIGHT BUTTONS  
HAZARD LIGHTS ON



## LOWER RIGHT BUTTON

SINGLE (1) TAP  
TOGGLE ENGINE POWER ON/OFF ONLY

HOLD BUTTON  
AUTO ENGINE ON + START/CRANK



FRONT BRAKE SWITCH WIRES

# TC3.P

## Dash Harness

TURNING DUMMY TO SMART LIGHTS

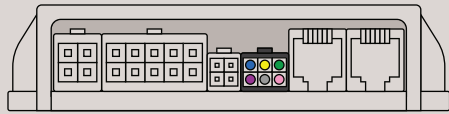

DASH PLUG



D



TURN HANDLEBAR LEFT AND RIGHT, LOCK TO LOCK, WHEN ROUTING DASH CABLES TO ENSURE YOU HAVE PROPER CABLE SLACK.

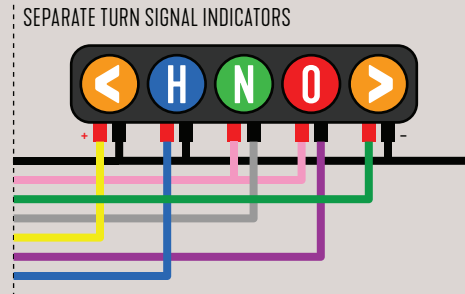
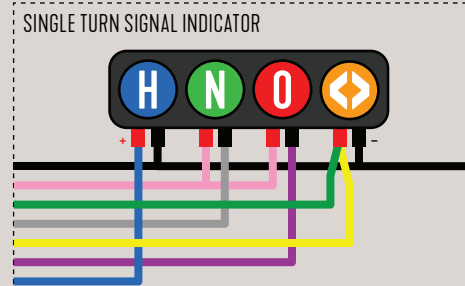
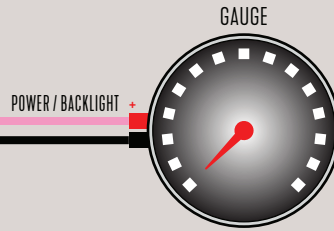

FRONT GND STRAP  
MOUNT ON MAIN FRAME/CHASSIS

16AWG DASH/DRL/HEADLIGHT  
18AWG HORN  
22AWG LEFT TURN SIGNAL LIGHT  
22AWG RIGHT TURN SIGNAL LIGHT

AVOID EXTENDING GROUND WIRES  
KEEP SHORT AS POSSIBLE.

# TC3.P

## Input Harness

RUN SENSE / NEUTRAL / OIL / R-BRAKE

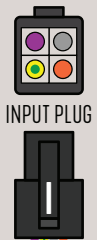
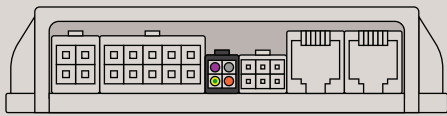

INPUT PLUG

SPARK COIL  
RUN SENSE

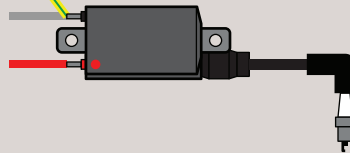

NEUTRAL  
SWITCH

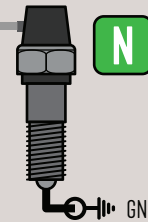

GND

REAR BRAKE SWITCH  
(PRESSURE)

(MECHANICAL)

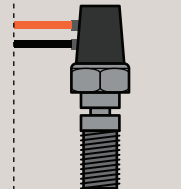

GND



OIL PRESSURE  
SWITCH

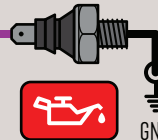

GND

CHECK SWITCHES FOR PROPER FUNCTIONALITY  
CLEAN/REBUILD/REPLACE WHEN NECESSARY

# TC3.P

## Output Harness

LIGHTING / HORN

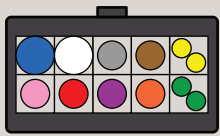
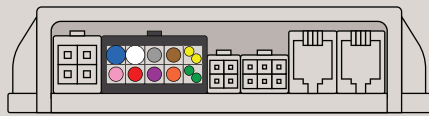

OUTPUT PLUG

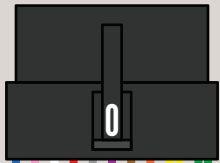

HRNX.105



LEFT TURN



HEADLIGHT

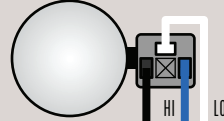

RIGHT TURN



FRONT GND STRAP  
MOUNT ON MAIN FRAME/CHASSIS

16AWG DASH/DRL/HEADLIGHT  
18AWG HORN  
22AWG LEFT TURN SIGNAL LIGHT  
22AWG RIGHT TURN SIGNAL LIGHT

AVOID EXTENDING GROUND WIRES  
KEEP SHORT AS POSSIBLE.

YOUR NEW GENERATION CONTROL HUB **DOES NOT NEED ANY ADDITIONAL PARTS** TO RUN LED LIGHTS. THEY PRODUCE LOW TO NO HEAT AND ARE ENERGY EFFICIENT.

PROTECTED KEY POWER

Output Harness:  
POWER / STARTING / CHARGING PAGE

Output Harness:  
ENGINE POWER / SPARK COILS PAGE



LEFT TURN



LICENSE PLATE/TAG

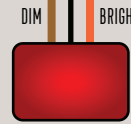

TAILLIGHT



RIGHT TURN

REAR GND STRAP  
MOUNT ON MAIN FRAME/CHASSIS

18AWG TAIL LIGHT  
22AWG LEFT TURN SIGNAL LIGHT  
22AWG RIGHT TURN SIGNAL LIGHT

DO NOT EXTEND OR LENGTHEN GND  
WIRES KEEP SHORT AS POSSIBLE.

# TC3.P Output Harness

ENGINE POWER / SPARK COILS

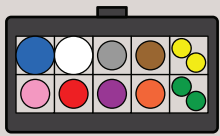
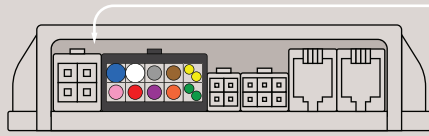

OUTPUT PLUG

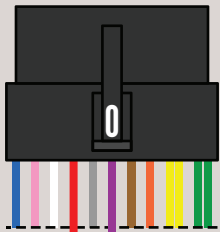

Output Harness:  
LIGHTING / HORN PAGE

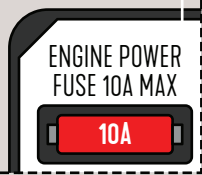

ENGINE POWER  
FUSE 10A MAX

10A

## POINTS BREAKER



WITH  
10A FUSE

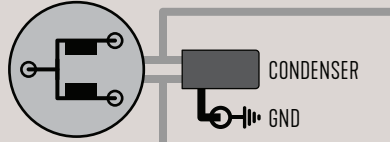

CONDENSER

GND

## CDI (CAPACITOR DISCHARGE IGNITER) / TCI (TRANSISTOR CONTROLLED IGNITER)



WITH  
10A FUSE

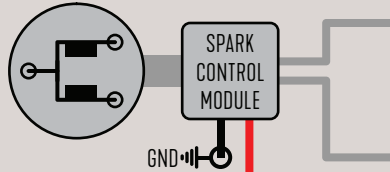

SPARK CONTROL  
MODULE

GND

## MAGNETO



NO FUSE

REMOVE PRE  
INSTALLED  
FUSE

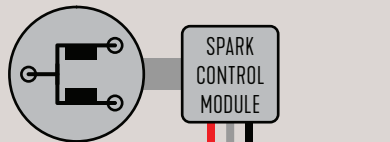

SPARK CONTROL  
MODULE

GND

IT IS ABSOLUTELY CRITICAL  
THE COIL **CENTER CORES**  
ARE GROUNDED SOLID,  
DIRECT METAL TO METAL  
ON THE MAIN CHASSIS.

CONFIRM YOUR  
SPARK COIL  
HAVE **2 WIRES**

SPARK COIL PAIRS  
(SINGLE or DUAL)

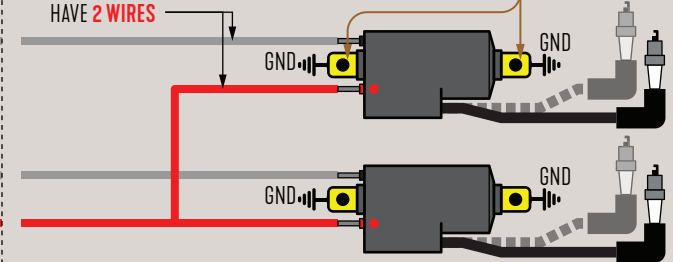

GND

GND

GND

GND

DO NOT ASSUME, CHECK!  
INSPECT, CLEAN AND SECURE SPARK PLUG CAP.  
HARD SPARK PLUG CABLES? INSPECT FOR BREAKS.  
EVEN BRAND NEW PARTS CAN BE DEFECTIVE.

CONFIRM YOUR SPARK COIL  
**ONLY HAVE 1 WIRE**

SPARK COIL (SINGLE)

GND

GND

SINGLE

SPARK COIL (DUAL)

GND

GND

DUAL

Output Harness:  
POWER / STARTING / CHARGING PAGE

# TC3.P

## Output Harness

POWER / STARTING / CHARGING

MODERNIZE YOUR CHARGING SYSTEM  
WITH A **DIGITAL TYPE** RECTIFIER+REGULATOR  
FOR SAFER AND MORE EFFICIENT CHARGING SOURCE

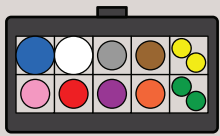
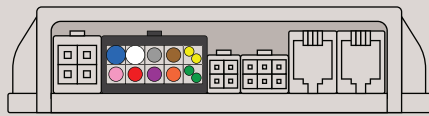

OUTPUT PLUG

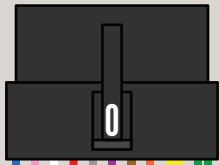

Output Harness:  
LIGHTING / HORN PAGE

Output Harness:  
ENGINE POWER / SPARK COILS PAGE

Power Harness  
PAGE

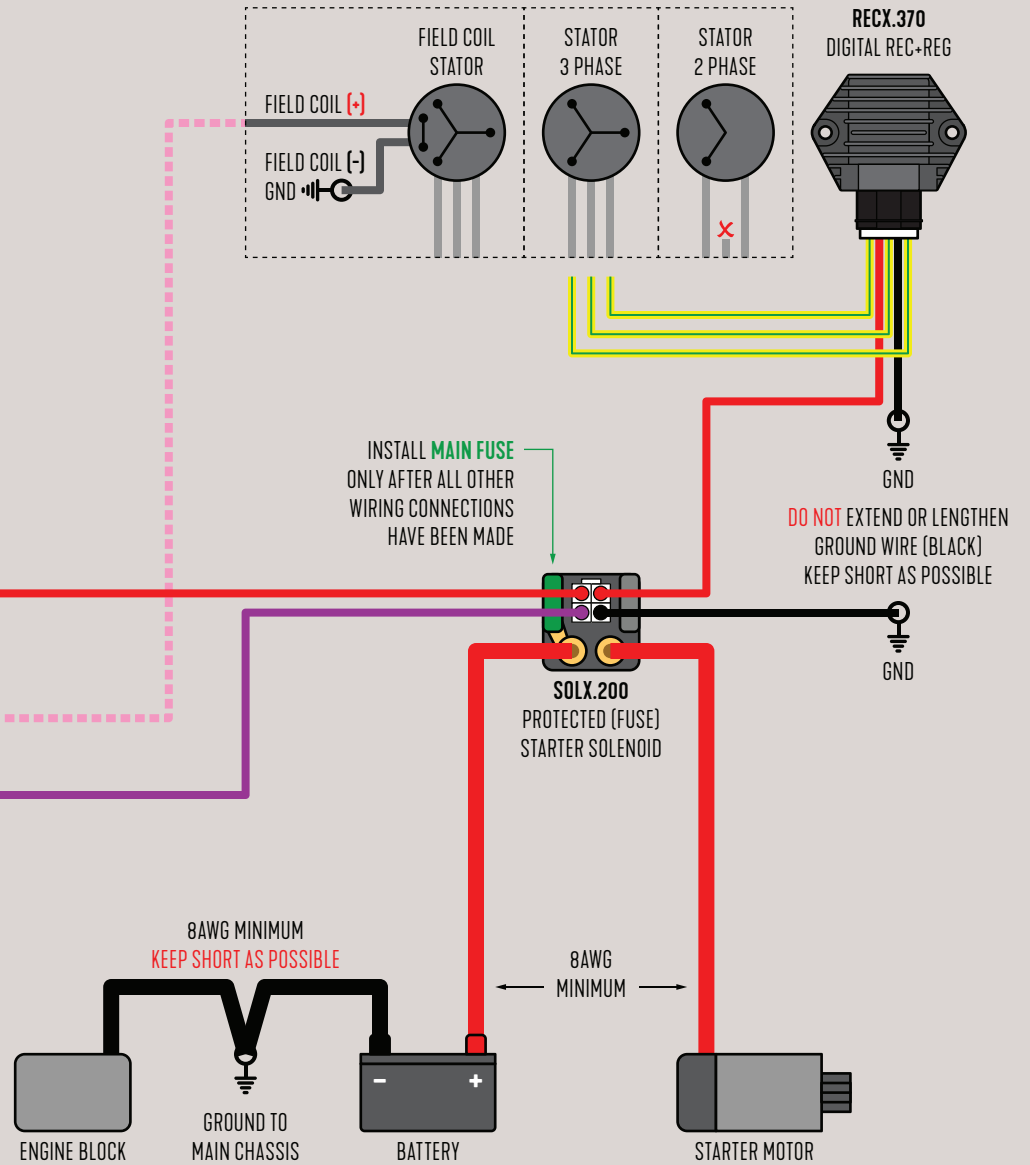



# TC3.P

## Power Harness KEY SWITCH

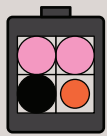
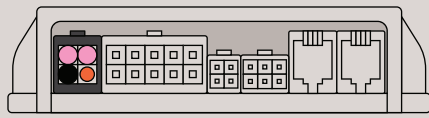

POWER PLUG

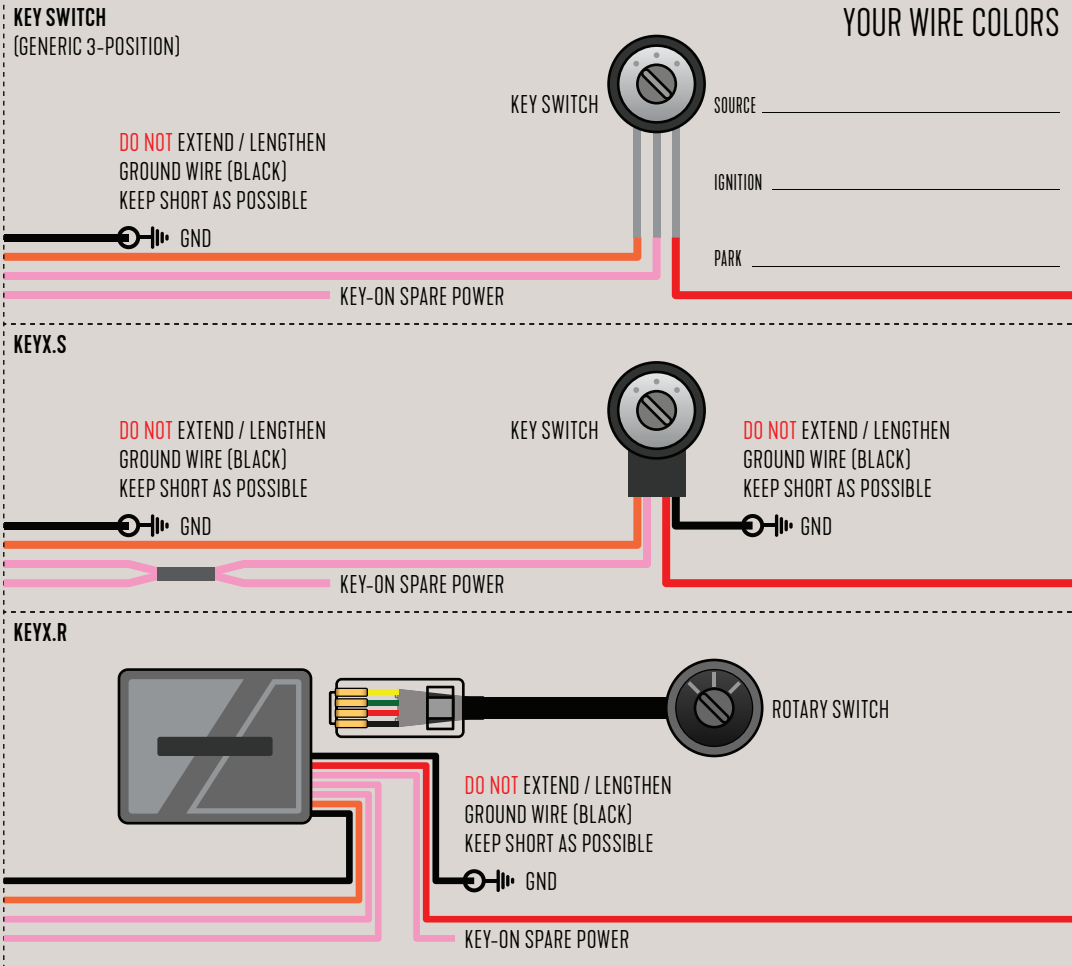

INSTALL MAIN FUSE ONLY AFTER ALL OTHER WIRING CONNECTIONS HAVE BEEN MADE

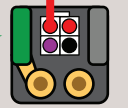

SOLX.200 PROTECTED (FUSE) STARTER SOLENOID