

# X3.S

## Control Hub STANDARD SWITCH

**FEATURES**

- Complete electrical control hub
- Atmel 8-bit AVR® RISC-based microcontroller
- Trench type MOSFET powered
- Solid State design for water-proof and shock-proof operation
- 4 layer PCB design utilizing SMD components
- PTC smart fuse protection with auto reset
- Optimized for LED lighting
- On board "fly-back" protection circuit
- AC/DC voltage runaway engine shutdown protection
- Charging system monitoring with fault audible notification
- Enhanced engine power protection with quick blow fuse
- Complete color-coded wiring harness
- No start ignition coil time-out power off
- Starter motor safety lock out with anti-grind
- Starter motor max crank time out
- Brake light flash pre-warning (Selectable)
- Automatic brake light HOLD (Selectable)
- Onboard digital flasher (Selectable)
- Intelligent directional switching signal light
- Signal light time out auto off
- DRL/Halo/Front Marker light output  
with TYPE 2 switchback (Selectable)
- "PARK" position light feature (Hazard lights)
- Master light control
- Sensor inputs
- Auxiliary sensor input/output
- Dash gauge outputs (Enhanced)
- Soft start headlight ON
- Engine run monitoring
- Multi-use internally protected power output
- Single wire PWM taillight output
- Sequential/self flashing signal light capable
- Handlebar switch size (7/8",22mm)
- 1 year replacement warranty & tech service

**INCLUDES**

- X3.S Control Hub
- Plug in wiring harness (Power, Output, Input, Dash)
- Plug&Go handlebar switch set (Standard/factory style)
- GND harness

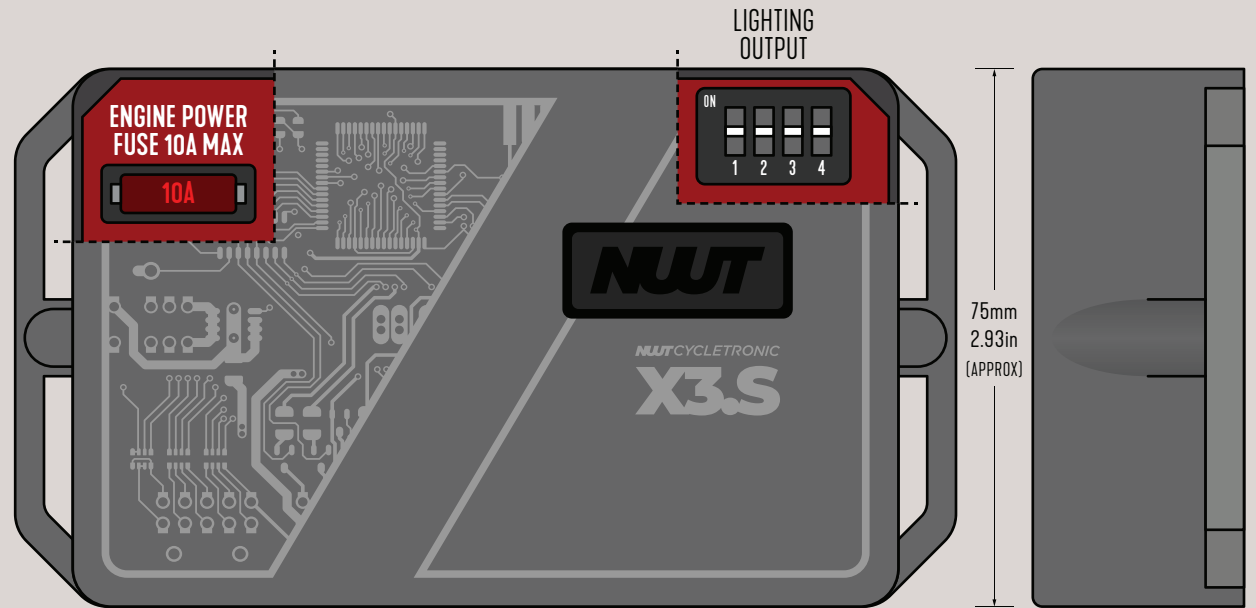

75mm  
2.93in  
(APPROX)

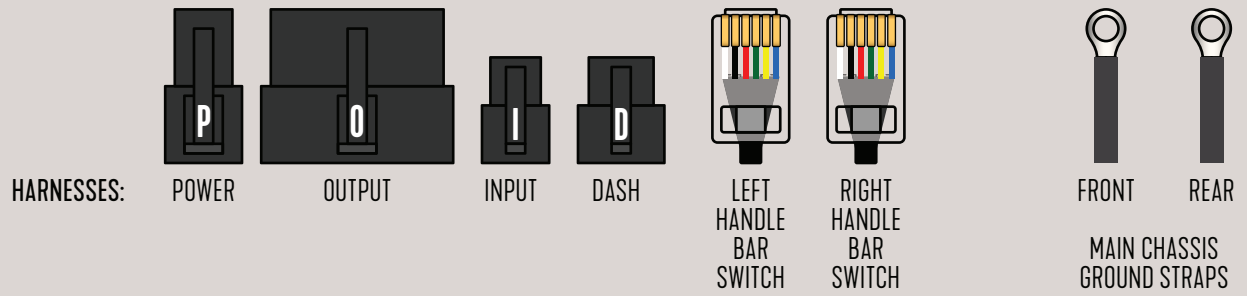
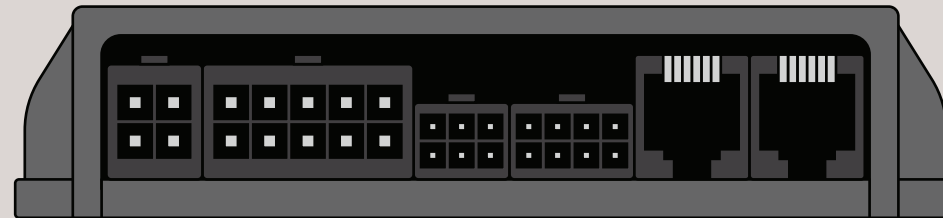

# X3.S

## Pinouts

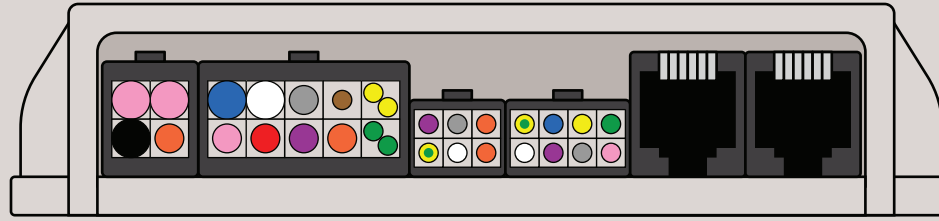

POWER      OUTPUT      INPUT      DASH      LEFT      RIGHT



### FRONT GND

GND	16AWG, 0.5m	(-)	DASH/DRL/HEADLIGHT
GND	18AWG, 0.5m	(-)	HORN
GND	22AWG, 0.5m	(-)	LEFT TURN SIGNAL LIGHT
GND	22AWG, 0.5m	(-)	RIGHT TURN SIGNAL LIGHT

### POWER

K+	16AWG, 1.25m	(+)	KEY SWITCH POWER IN (LONG)
GND	16AWG, 0.25m	(-)	CHASSIS GROUND IN
S+	16AWG, 0.25m	(+)	SPARE SWITCH POWER OUT (SHORT)
P+	18AWG, 1.25m	(+)	PARK LIGHT SWITCH IN

### OUTPUT

HI	16AWG, 1.25m	(+)	HEADLIGHT HIGH BEAM
F+	18AWG, 0.25m	(+)	PROTECTED POWER
LO	16AWG, 1.25m	(+)	HEADLIGHT LOW BEAM
ENGINE	18AWG, 0.75m	(+)	ENGINE IGNITION POWER
HORN	18AWG, 0.75m	(+)	HORN
STARTER	18AWG, 0.5m	(+)	STARTER SOLENOID / RELAY
FRONT LIGHT	22AWG, 0.75m	(+)	DRL / HALO / FRONT MARKER
TAILLIGHT	18AWG, 0.75m	(+)	TAILLIGHT
LEFT TURN	(2) 22AWG, 1.25m, 0.75m	(+)	LEFT TURN SIGNAL LIGHTS (FRONT & REAR)
RIGHT TURN	(2) 22AWG, 1.25m, 0.75m	(+)	RIGHT TURN SIGNAL LIGHTS (FRONT & REAR)

### INPUT

OIL	22AWG, 0.75m	(-)	OIL SWITCH
RUN SENSE	22AWG, 0.75m	(~)	IGNITION COIL TRIGGER
NEUTRAL	22AWG, 0.75m	(-)	NEUTRAL SWITCH
AUX	22AWG, 0.75m	(~)	AUX SENSOR / SWITCH / INPUT
BRAKE	22AWG, 0.75m	(-)	BRAKE SWITCH IN
BRAKE	22AWG, 0.75m	(-)	BRAKE SWITCH OUT

### REAR GND

GND	18AWG, 0.5m	(-)	BRAKE/TAIL LIGHT
GND	22AWG, 0.5m	(-)	RIGHT TURN SIGNAL LIGHT
GND	22AWG, 0.5m	(-)	LEFT TURN SIGNAL LIGHT

RIGHT  
HANDLEBAR  
SWITCH

LEFT  
HANDLEBAR  
SWITCH

### DASH

D+	22AWG, 1.25m	(+)	GAUGE POWER
RIGHT TURN	22AWG, 1.25m	(+)	RIGHT TURN INDICATOR
NEUTRAL	22AWG, 1.25m	(-)	NEUTRAL INDICATOR
LEFT TURN	22AWG, 1.25m	(+)	LEFT TURN INDICATOR
OIL	22AWG, 1.25m	(-)	OIL INDICATOR
HI	22AWG, 1.25m	(+)	HIGH BEAM INDICATOR
AUX	22AWG, 1.25m	(~)	AUX OUTPUT
TACH	22AWG, 1.25m	(~)	TACH PULSE

# X3.S

## Switch Set

Plug&Go STANDARD/FACTORY TYPE

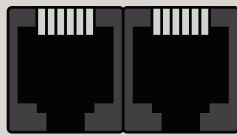
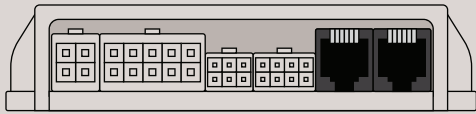

LEFT

RIGHT

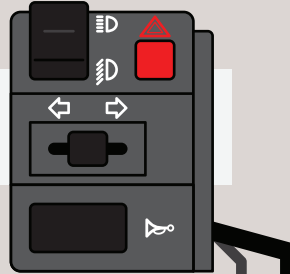
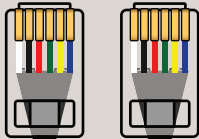

CLUTCH  
SWITCH WIRES  
Connect together if NO switch.



FRONT BRAKE  
SWITCH WIRES

TURN HANDLEBAR LEFT AND RIGHT, LOCK TO  
LOCK, WHEN ROUTING SWITCH SET CABLES TO  
ENSURE YOU HAVE PROPER CABLE SLACK.

# X3.S

## Dash Harness

TURNING DUMMY TO SMART LIGHTS

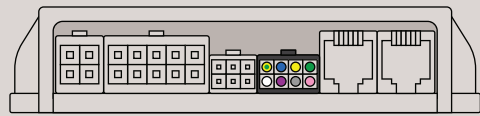

DASH PLUG

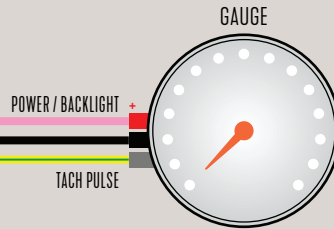

POWER / BACKLIGHT

TACH PULSE

SINGLE TURN SIGNAL INDICATOR



SEPARATE TURN SIGNAL INDICATORS



TURN HANDLEBAR LEFT AND RIGHT, LOCK TO LOCK, WHEN ROUTING DASH CABLES TO ENSURE YOU HAVE PROPER CABLE SLACK.

AUX



FRONT GND STRAP  
MOUNT ON MAIN FRAME/CHASSIS

16AWG DASH/DRL/HEADLIGHT  
18AWG HORN  
22AWG LEFT TURN SIGNAL LIGHT  
22AWG RIGHT TURN SIGNAL LIGHT

AVOID EXTENDING GROUND WIRES  
KEEP SHORT AS POSSIBLE.

# X3.S

## Input Harness

RUN SENSE / NEUTRAL / OIL / R-BRAKE

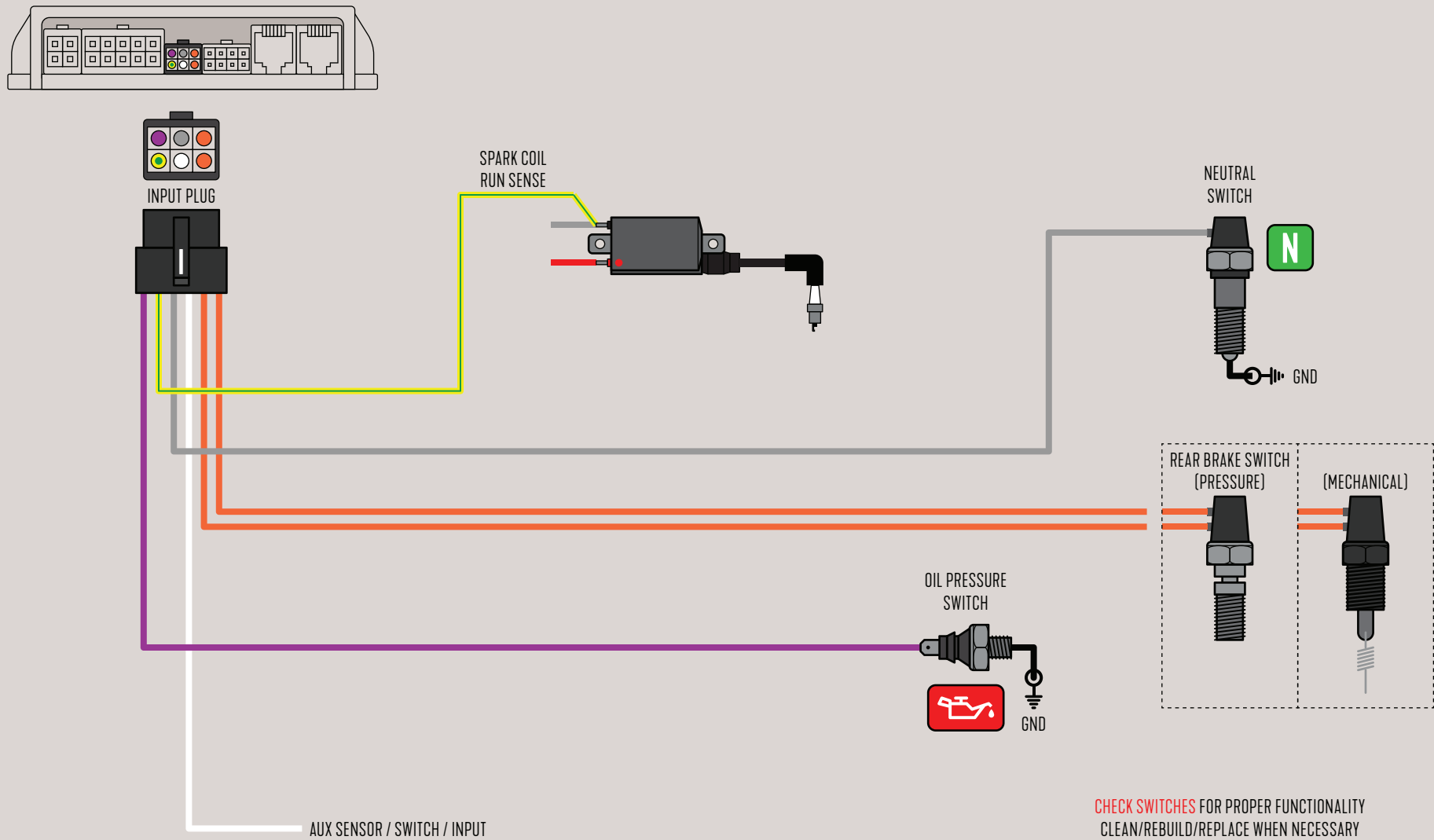

CHECK SWITCHES FOR PROPER FUNCTIONALITY  
CLEAN/REBUILD/REPLACE WHEN NECESSARY

# X3.S

## Output Harness

LIGHTING / HORN

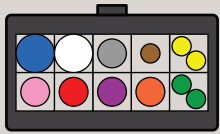
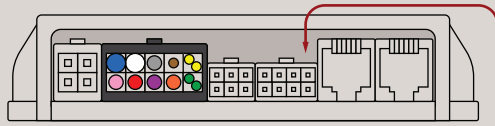

LIGHTING OUTPUT SETTINGS INSIDE

OUTPUT PLUG

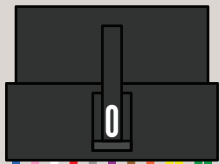

HRNX.105

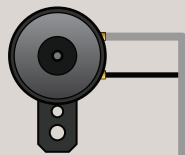

### DIGITAL FLASHER OPTION



↑ REGULAR TURN SIGNALS OR  
↓ SELF-FLASHING / SEQUENTIAL (FLOWING)

REGULAR SINGLE ELEMENT



REGULAR DUAL ELEMENT



SELF-FLASHING / SEQUENTIAL (FLOWING)

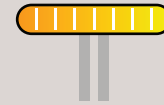

### FRONT LIGHTING OPTION A



HALO/DRL ONLY  
NO MARKERS

↑ 2 UP

LEFT TURN



HEADLIGHT

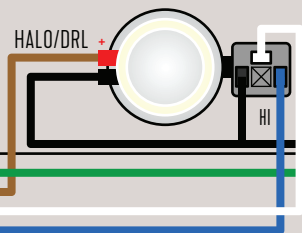

RIGHT TURN



### FRONT LIGHTING OPTION B



NO HALO/DRL MARKERS ONLY

↓ 2 DOWN

LEFT TURN



HEADLIGHT

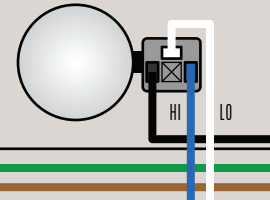

RIGHT TURN



### TAILLIGHT FEATURES

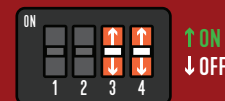

3 | 4  
BRAKE FLASH PRE WARNING | AUTOMATIC BRAKE HOLD

↑ ON  
↓ OFF

DIM

BRIGHT



TAILLIGHT

RIGHT TURN



FRONT GND STRAP

MOUNT ON MAIN FRAME/CHASSIS

16AWG DASH/DRL/HEADLIGHT

18AWG HORN

22AWG LEFT TURN SIGNAL LIGHT

22AWG RIGHT TURN SIGNAL LIGHT

AVOID EXTENDING GROUND WIRES  
KEEP SHORT AS POSSIBLE.

YOUR NEW GENERATION CONTROL HUB DOES NOT NEED ANY ADDITIONAL PARTS TO RUN LED LIGHTS. THEY PRODUCE LOW TO NO HEAT AND ARE ENERGY EFFICIENT.

REAR GND STRAP

MOUNT ON MAIN FRAME/CHASSIS

18AWG TAIL LIGHT

22AWG LEFT TURN SIGNAL LIGHT

22AWG RIGHT TURN SIGNAL LIGHT

DO NOT EXTEND OR LENGTHEN GND WIRES  
KEEP SHORT AS POSSIBLE.

Output Harness:  
POWER / STARTING / CHARGING PAGE

Output Harness:  
ENGINE POWER / SPARK COILS PAGE

# X3.S

## Output Harness

ENGINE POWER / SPARK COILS

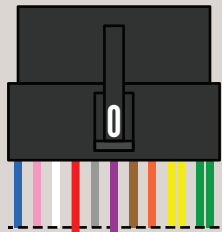
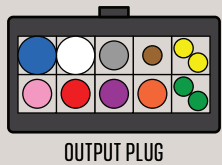
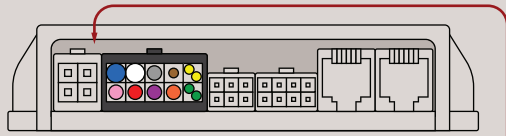

Output Harness:  
LIGHTING / HORN PAGE

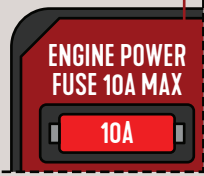

Output Harness:  
POWER / STARTING / CHARGING PAGE

### POINTS BREAKER

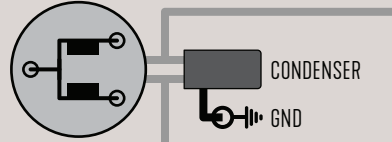
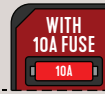

### CDI (CAPACITOR DISCHARGE IGNITER) / TCI (TRANSISTOR CONTROLLED IGNITER)

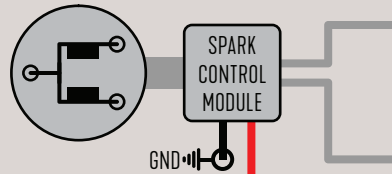

### MAGNETO



REMOVE PRE  
INSTALLED  
FUSE

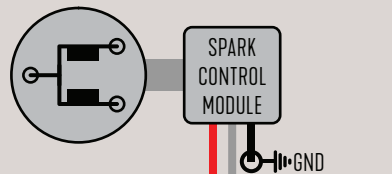

IT IS ABSOLUTELY CRITICAL  
THE COIL **CENTER CORES**  
ARE GROUNDED SOLID,  
DIRECT METAL TO METAL  
ON THE MAIN CHASSIS.

CONFIRM YOUR  
SPARK COIL  
HAVE **2 WIRES**

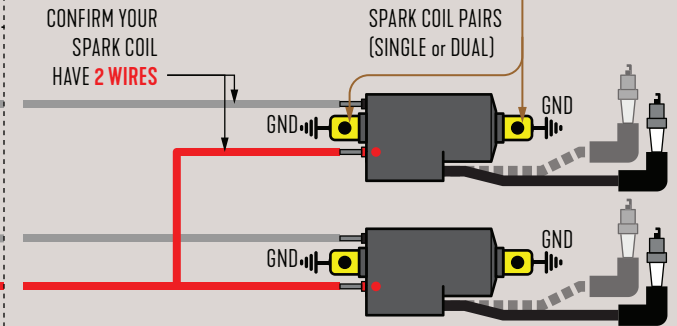

DO NOT ASSUME, CHECK!  
INSPECT, CLEAN AND SECURE SPARK PLUG CAP.  
HARD SPARK PLUG CABLES? INSPECT FOR BREAKS.  
EVEN BRAND NEW PARTS CAN BE DEFECTIVE.

CONFIRM YOUR SPARK COIL  
**ONLY HAVE 1 WIRE**

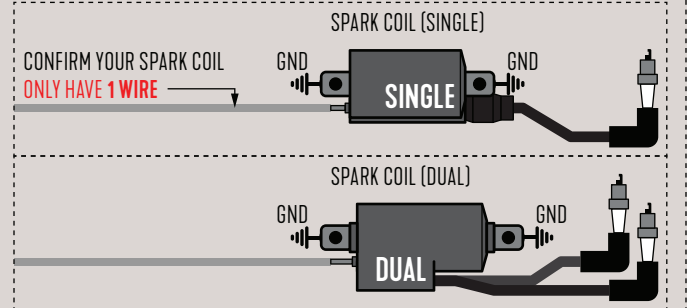

# X3.S

## Output Harness

POWER / STARTING / CHARGING

MODERNIZE YOUR CHARGING SYSTEM  
WITH A **DIGITAL TYPE** RECTIFIER+REGULATOR  
FOR SAFER AND MORE EFFICIENT CHARGING SOURCE

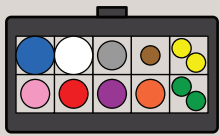

OUTPUT PLUG

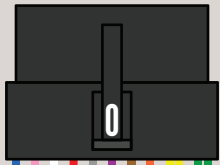

Output Harness:  
LIGHTING / HORN PAGE

Output Harness:  
ENGINE POWER / SPARK COILS PAGE

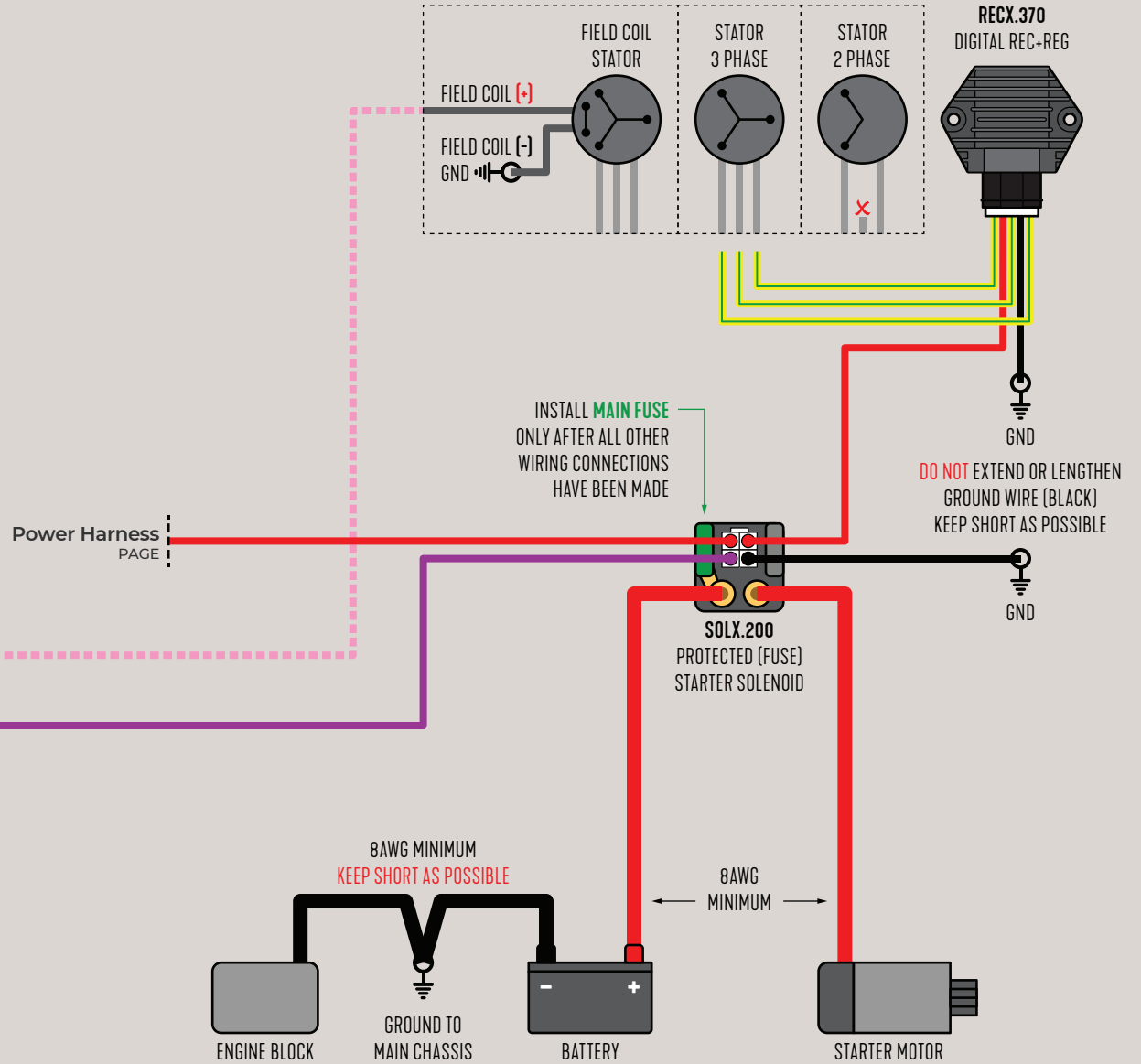



# X3.S

## Power Harness KEY SWITCH

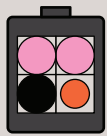
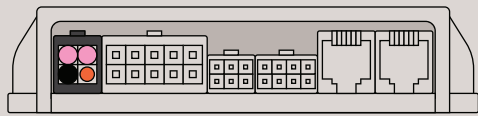

POWER PLUG

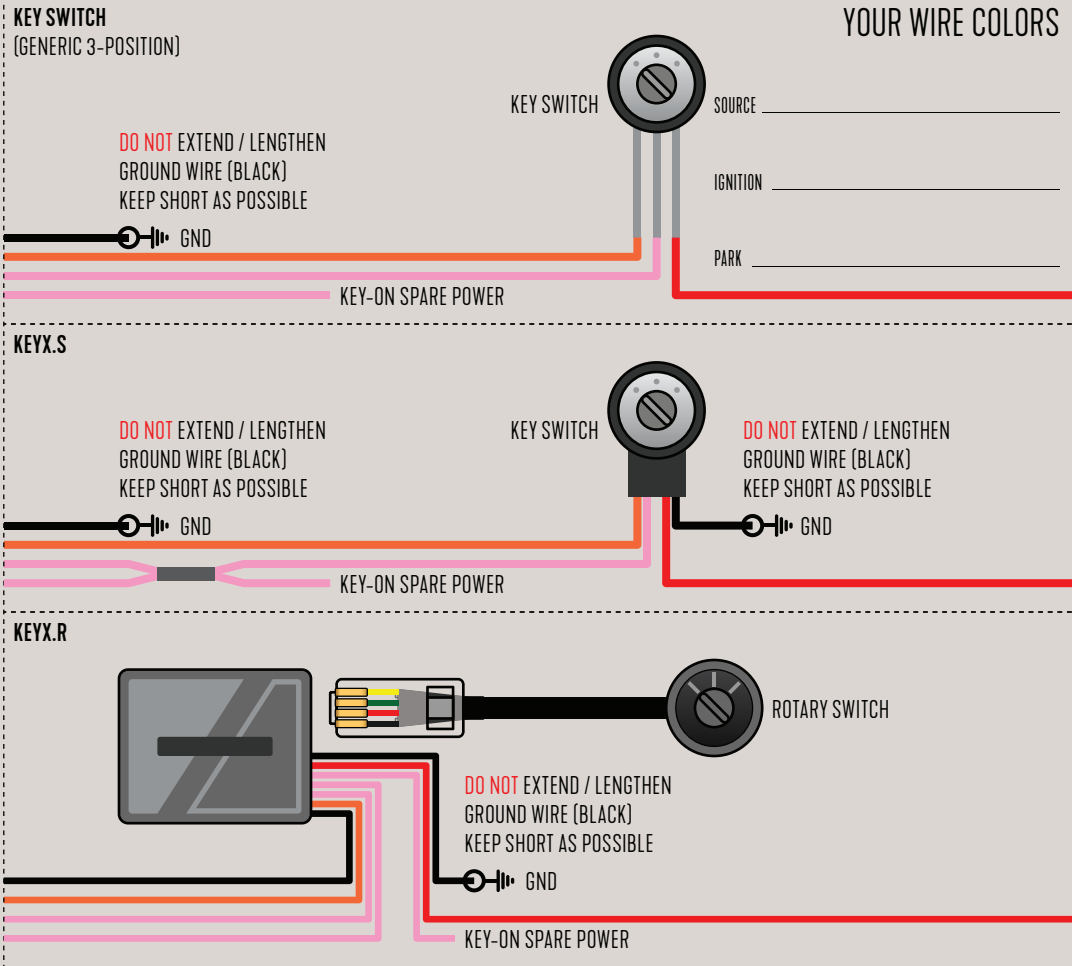

INSTALL MAIN FUSE ONLY AFTER ALL OTHER WIRING CONNECTIONS HAVE BEEN MADE

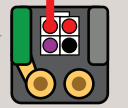

SOLX.200 PROTECTED (FUSE) STARTER SOLENOID